



INSTALLATION MANUAL

Alpha 6520

Alpha 6530

Alpha 4020





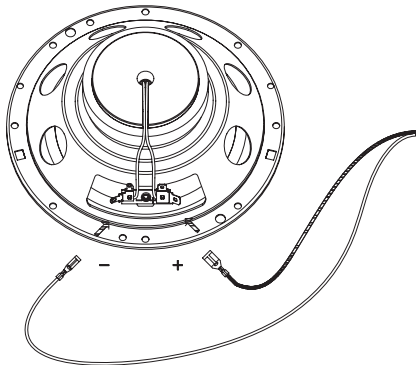
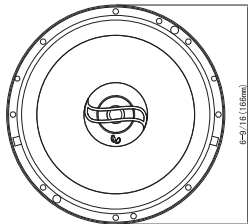
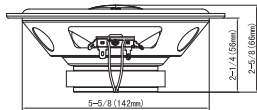

Alpha 6930

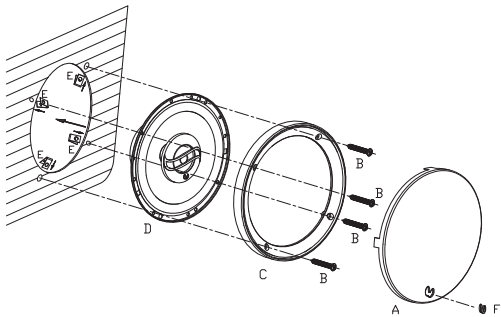
Alpha 650C

Alpha 6520





<p>A</p>  <p>2x</p>	<p>B</p>  <p>8x</p>	<p>C</p>  <p>2x</p>	<p>D</p>  <p>2x</p>	<p>E</p>  <p>8x</p>	<p>F</p>  <p>2x</p>
------------------------------------------------------------------------------------------------------	------------------------------------------------------------------------------------------------------	------------------------------------------------------------------------------------------------------	------------------------------------------------------------------------------------------------------	--------------------------------------------------------------------------------------------------------	--------------------------------------------------------------------------------------------------------

Specifications

- Type: 6-1/2" (160mm) 2-way coaxial car speaker
- Power Handling: 40Wrms, 280W peak
- Sensitivity (@ 2.83V): 91dB
- Frequency Response: 55Hz – 20kHz
- Nominal Impedance: 4ohms



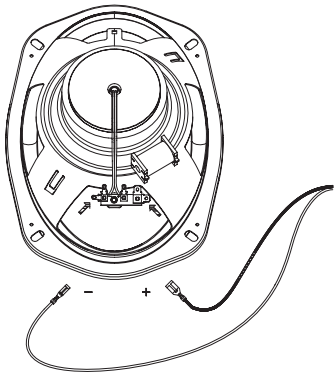
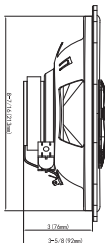
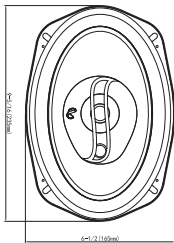
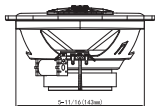

Thiele-Small Parameters

- BL (Tm): 3.241
- DCR (ohm): 3.2
- Mms (g): 8.031
- Sd (cm²): 128.68
- Cms (μm/N): 427.874
- Vas (l): 10.061
- Fs (Hz): 85
- Qes: 1.32
- Qms: 4.242
- Qts: 1.007
- Crossover Point: 5.8 kHz

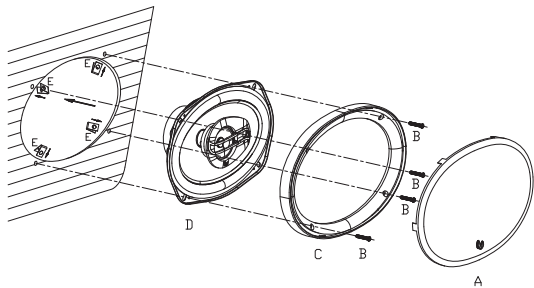
Alpha 6930





<p>A</p>  <p>2x</p>	<p>B</p>  <p>8x</p>	<p>C</p>  <p>2x</p>	<p>D</p>  <p>2x</p>	<p>E</p>  <p>8x</p>
------------------------------------------------------------------------------------------------------	------------------------------------------------------------------------------------------------------	------------------------------------------------------------------------------------------------------	-------------------------------------------------------------------------------------------------------	--------------------------------------------------------------------------------------------------------

Specifications

- Type: 6" x 9"(152mm x 230mm) 3way coaxial car speaker
- Power Handling: 70Wrms, 490W peak
- Sensitivity (@ 2.83V): 92dB
- Frequency Response: 50Hz – 21kHz
- Nominal Impedance: 4ohms





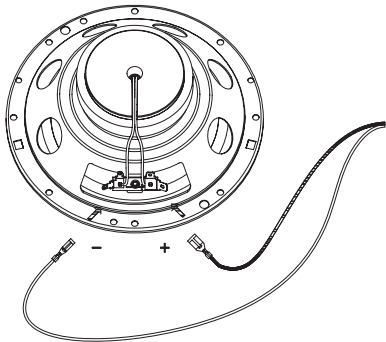
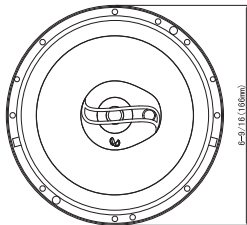
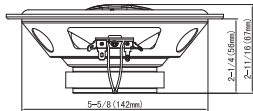

Thiele-Small Parameters

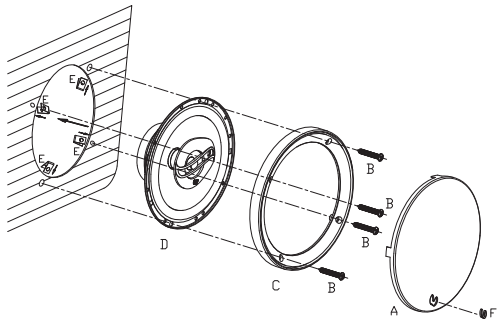
- BL (Tm): 3.496
- DCR (ohm): 2.3
- Mms (g): 17.755
- Sd (cm²): 213.565
- Cms (μm/N): 306.333
- Vas (l): 19.84
- Fs (Hz): 70
- Qes: 1.432
- Qms: 3.99
- Qts: 1.054
- Crossover Point: 3.6 kHz

Alpha 6530





<p>A</p>  <p>2x</p>	<p>B</p>  <p>8x</p>	<p>C</p>  <p>2x</p>	<p>D</p>  <p>2x</p>	<p>E</p>  <p>8x</p>	<p>F</p>  <p>2x</p>
------------------------------------------------------------------------------------------------------	------------------------------------------------------------------------------------------------------	------------------------------------------------------------------------------------------------------	------------------------------------------------------------------------------------------------------	--------------------------------------------------------------------------------------------------------	--------------------------------------------------------------------------------------------------------

Specifications

- Type: 6-1/2" (160mm) 3way coaxial car speaker
- Power Handling: 40Wrms, 290W peak
- Sensitivity (@ 2.83V): 91dB
- Frequency Response: 55Hz – 20kHz
- Nominal Impedance: 4ohms

Thiele-Small Parameters





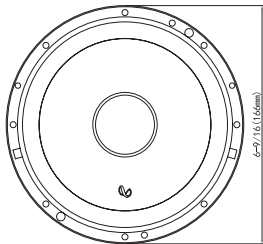
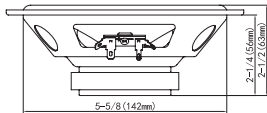

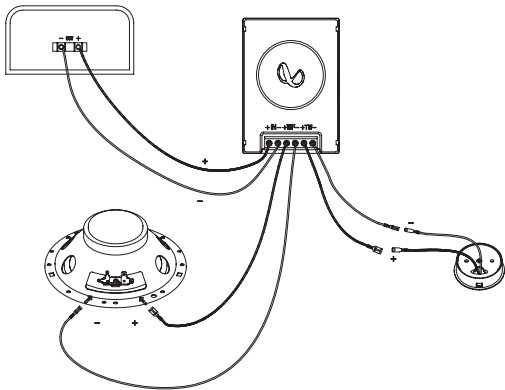

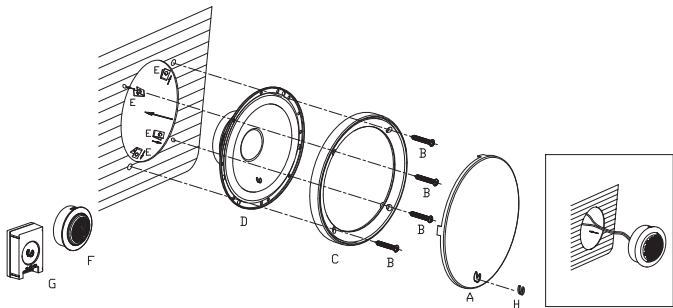
- BL (Tm): 3.241
- DCR (ohm): 3.2
- Mms (g): 8.031
- Sd (cm²): 128.68
- Cms (μm/N): 427.874
- Vas (l): 10.061
- Fs (Hz): 85
- Qes: 1.32
- Qms: 4.242
- Qts: 1.007
- Crossover Point: 5.8 kHz

Alpha 650C







<p>A</p>  <p>2x</p>	<p>B</p>  <p>8x</p>	<p>C</p>  <p>2x</p>	<p>D</p>  <p>2x</p>	<p>E</p>  <p>8x</p>	<p>F</p>  <p>2x</p>	<p>G</p>  <p>2x</p>	<p>H</p>  <p>2x</p>
------------------------------------------------------------------------------------------------------	------------------------------------------------------------------------------------------------------	------------------------------------------------------------------------------------------------------	------------------------------------------------------------------------------------------------------	------------------------------------------------------------------------------------------------------	-------------------------------------------------------------------------------------------------------	--------------------------------------------------------------------------------------------------------	--------------------------------------------------------------------------------------------------------

Specifications

- Type: 6-1/2" (165mm) 2way component system car speaker
- Power Handling: 45Wrms, 315W peak
- Sensitivity (@ 2.83V): 91dB
- Frequency Response: 55Hz – 20kHz
- Impedance: 4ohms



Thiele-Small Parameters

- BL (Tm): 3.588
- DCR (ohm): 3.2
- Mms (g): 11.01
- Sd (cm²): 128.68
- Cms (μm/N): 348.261
- Vas (l): 8.189
- Fs (Hz): 85
- Qes: 1.398
- Qms: 3.618
- Qts: 1.008
- Crossover Point: 5.0 kHz

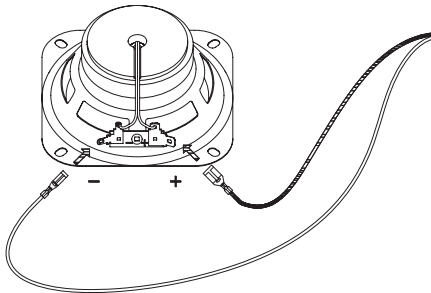
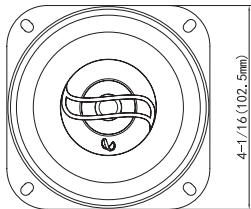
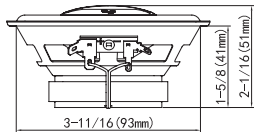
Alpha 4020

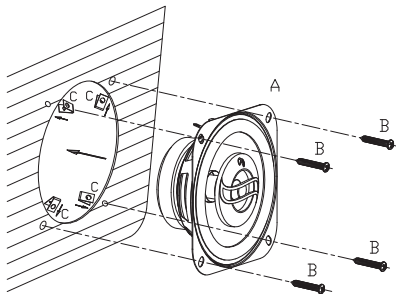



<p>A</p>  <p>2x</p>	<p>B</p>  <p>8x</p>	<p>C</p>  <p>8x</p>
------------------------------------------------------------------------------------------------------	------------------------------------------------------------------------------------------------------	------------------------------------------------------------------------------------------------------

Specifications

- Type: 4" (100mm) 2way coaxial car speaker
- Power Handling: 25W RMS, 175W peak
- Sensitivity (@ 2.83V): 88dB
- Frequency Response: 75Hz – 20kHz
- Nominal Impedance: 4 ohms

Thiele-Small Parameters

- BL (Tm): 2.965
- DCR (ohm): 3.2
- Mms (g): 4.629
- Sd (cm²): 55.389
- Cms (μm/N): 409.235
- Vas (l): 1.785
- Fs (Hz): 115
- Qes: 1.224
- Qms: 4.583
- Qts: 0.966
- Crossover Point: 8.0 kHz



HARMAN International Industries,
Incorporated, 8500 Balboa
Boulevard, Northridge, CA 91329
USA

© 2019 HARMAN International
Industries, Incorporated. All

rights reserved. JBL is a trademark of HARMAN International
Industries, Incorporated, registered in the United States and/or
other countries.

Features, specifications and appearance are subject to change
without notice.